

XM12025T4

N-Channel SiC Power MOSFET

V_{DS}	=	1200	V
$R_{DS(on)}$	=	25	mΩ
$I_D@25^{\circ}C$	=	65	A

Features

- High Blocking Voltage with Low On-Resistance
- High Speed Switching with Low Capacitance
- Easy to Parallel and Simple to Drive

Benefits

- Higher System Efficiency
- Reduced Cooling Requirements
- Increased Power Density
- Increased System Switching Frequency

Applications

- Power Supplies
- High Voltage DC/DC Converters
- Motor Drives
- Switch Mode Power Supplies
- Pulsed Power applications

Package

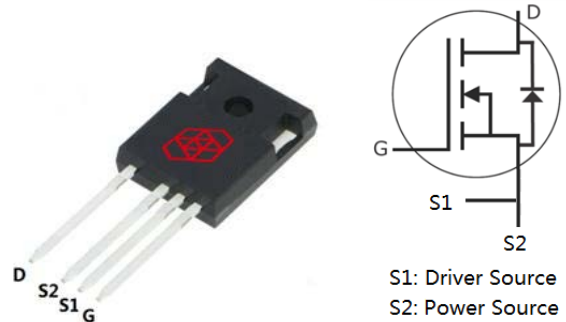

Part Number	Package
XM12025T4	TO-247-4

Maximum Ratings ($T_c=25^{\circ}C$ unless otherwise specified)

Symbol	Parameter	Value	Unit	Test Conditions	Note
V_{DSmax}	Drain-Source Voltage	1200	V	$V_{GS}=0V, I_D=100\mu A$	
V_{GSmax}	Gate-Source Voltage	-10/+25	V	Absolute maximum values	
V_{GSop}	Gate-Source Voltage	-5/+20	V	Recommended operational values	
I_D	Continuous Drain Current	65	A	$V_{GS}=20V, T_c=25^{\circ}C$	
		43		$V_{GS}=20V, T_c=100^{\circ}C$	
$I_{D(pulse)}$	Pulsed Drain Current	200	A	Pulse width t_p limited by T_{Jmax}	
P_D	Power Dissipation	370	W	$T_c=25^{\circ}C, T_J=150^{\circ}C$	
T_J, T_{STG}	Operating Junction and Storage Temperature	-55 to +150	$^{\circ}C$		



Electrical Characteristics ($T_c=25^\circ\text{C}$ unless otherwise specified)

Symbol	Parameter	Min.	Typ.	Max.	Unit	Test Conditions	Note
$V_{(BR)DSS}$	Drain-Source Breakdown Voltage	1200	/	/	V	$V_{GS}=0V, I_D=100\mu A$	
$V_{GS(th)}$	Gate Threshold Voltage	1.9	2.4	4.0	V	$V_{DS}=V_{GS}, I_D=15mA$	Fig. 11
		/	1.7	/		$V_{DS}=V_{GS}, I_D=15mA, T_J=150^\circ\text{C}$	
I_{DSS}	Zero Gate Voltage Drain Current	/	1	100	μA	$V_{DS}=1200V, V_{GS}=0V$	
I_{GSS+}	Gate-Source Leakage Current	/	10	250	nA	$V_{DS}=0V, V_{GS}=25V$	
I_{GSS-}	Gate-Source Leakage Current	/	10	250	nA	$V_{DS}=0V, V_{GS}=-10V$	
$R_{DS(on)}$	Drain-Source On-State Resistance	/	25	34	m Ω	$V_{GS}=20V, I_D=50A$	Fig. 4,5,6
		/	43	/		$V_{GS}=20V, I_D=50A, T_J=150^\circ\text{C}$	
C_{iss}	Input Capacitance	/	4200	/	pF	$V_{GS}=0V$	Fig. 15,16
C_{oss}	Output Capacitance	/	250	/		$V_{DS}=1000V$	
C_{rss}	Reverse Transfer Capacitance	/	16	/		$f=1MHz$	
E_{oss}	C_{oss} Stored Energy	/	126	/		$V_{AC}=25mV$	
E_{ON}	Turn-On Switching Energy	/	1.8	/	mJ	$V_{DS}=800V, V_{GS}=-5V/20V$	
E_{OFF}	Turn-Off Switching Energy	/	0.6	/		$I_D=50A, R_{G(ext)}=2.5\Omega, L=412\mu H$	
$t_{d(on)}$	Turn-On Delay Time	/	15	/	ns	$V_{DS}=800V, V_{GS}=-5V/20V, I_D=50A$ $R_{G(ext)}=2.5\Omega, R_L=16\Omega$	
t_r	Rise Time	/	12	/			
$t_{d(off)}$	Turn-Off Delay Time	/	34	/			
t_f	Fall Time	/	7	/			
$R_{G(int)}$	Internal Gate Resistance	/	2.1	/	Ω	$f=1MHz, V_{AC}=25mV$	
Q_{GS}	Gate to Source Charge	/	54	/	nC	$V_{DS}=800V$	
Q_{GD}	Gate to Drain Charge	/	29	/		$V_{GS}=-5V/20V$	
Q_G	Total Gate Charge	/	195	/		$I_D=50A$	

Reverse Diode Characteristics

Symbol	Parameter	Typ.	Max.	Unit	Test Conditions	Note
V_{SD}	Diode Forward Voltage	3.5	/	V	$V_{GS}=-5V, I_{SD}=25A$	Fig. 8,9,10
		3.3	/		$V_{GS}=-5V, I_{SD}=25A, T_J=150^\circ\text{C}$	
I_S	Continuous Diode Forward Current	/	98	A	$T_c=25^\circ\text{C}$	
t_{rr}	Reverse Recover Time	50	/	ns	$V_R=800V, I_{SD}=50A$	
Q_{rr}	Reverse Recovery Charge	216	/	nC		
I_{rrm}	Peak Reverse Recovery Current	7.2	/	A		

Thermal Characteristics

Symbol	Parameter	Typ.	Max.	Unit	Test Conditions	Note
$R_{\theta JC}$	Thermal Resistance from Junction to Case	0.25	/	$^\circ\text{C/W}$		
$R_{\theta JA}$	Thermal Resistance from Junction to Ambient	/	40			

Typical Performance

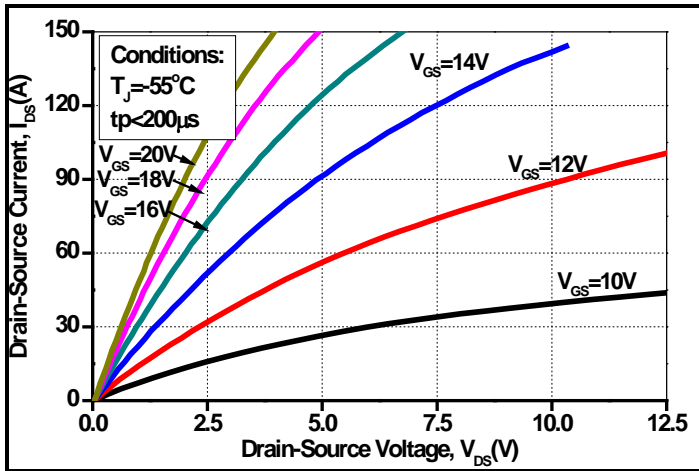

Figure 1. Output Characteristics $T_j = -55^\circ\text{C}$

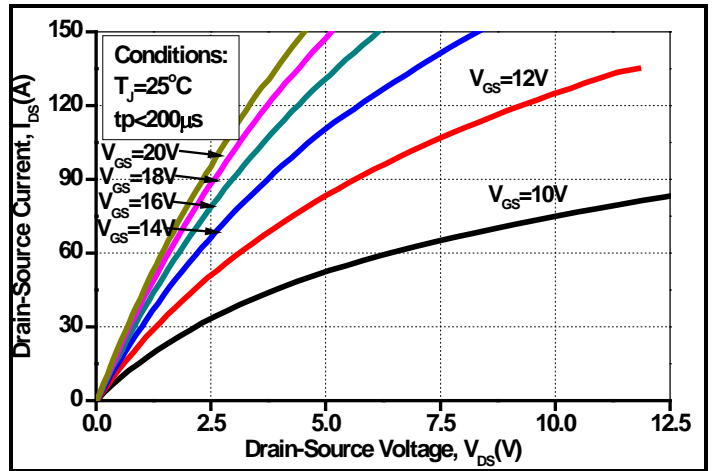

Figure 2. Output Characteristics $T_j = 25^\circ\text{C}$

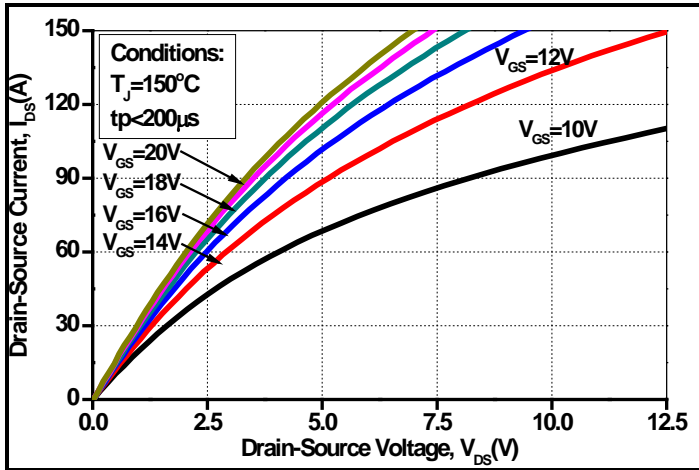

Figure 3. Output Characteristics $T_j = 150^\circ\text{C}$

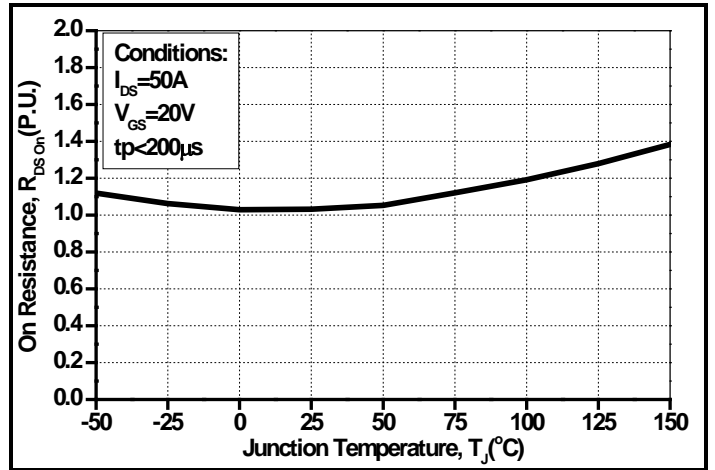

Figure 4. Normalized On-Resistance vs. Temperature

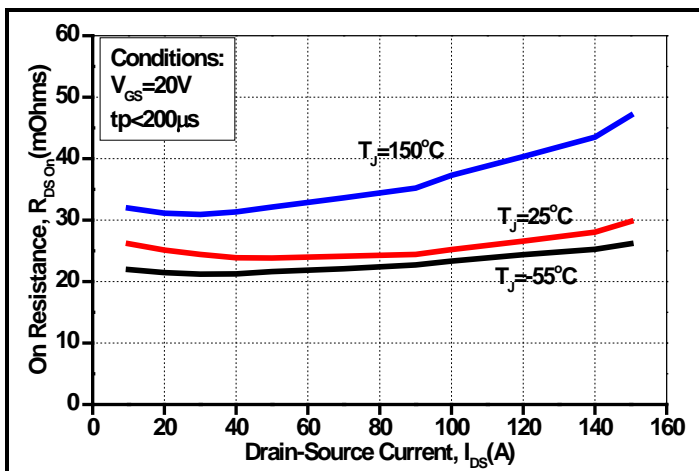

Figure 5. On-Resistance vs. Drain Current
For Various Temperatures

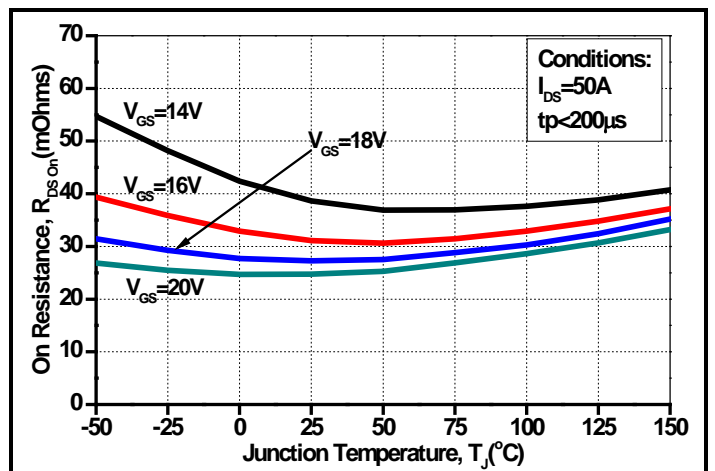

Figure 6. On-Resistance vs. Temperature
For Various Gate Voltage



Typical Performance

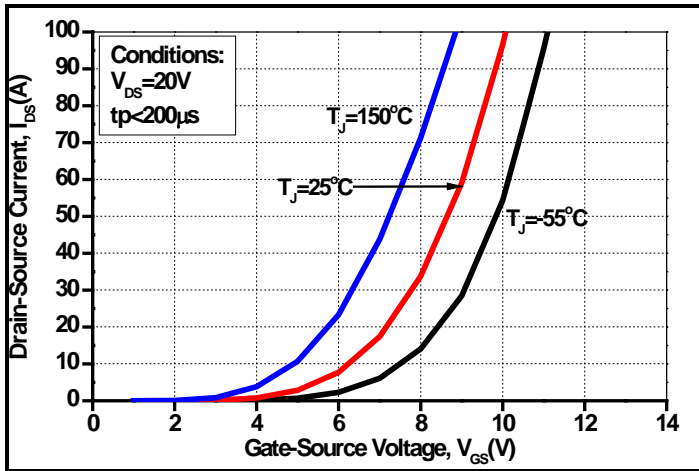

Figure 7. Transfer Characteristic for Various Junction Temperatures

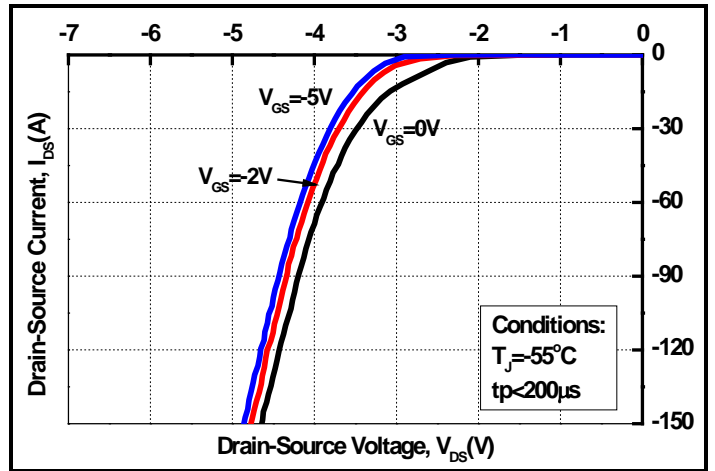

Figure 8. Body Diode Characteristic at -55°C

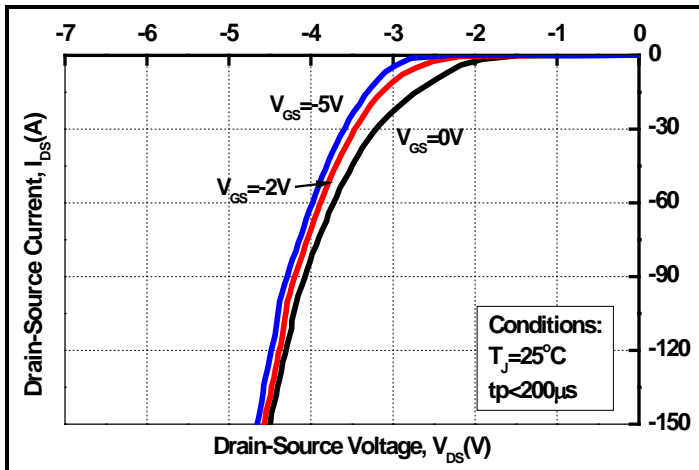

Figure 9. Body Diode Characteristic at 25°C

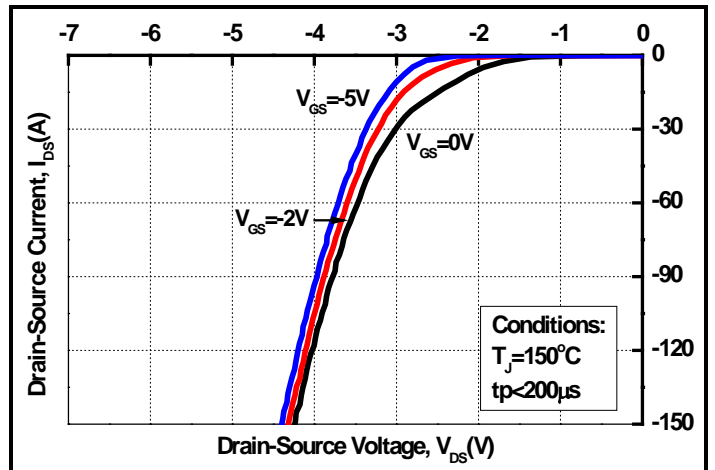

Figure 10. Body Diode Characteristic at 150°C

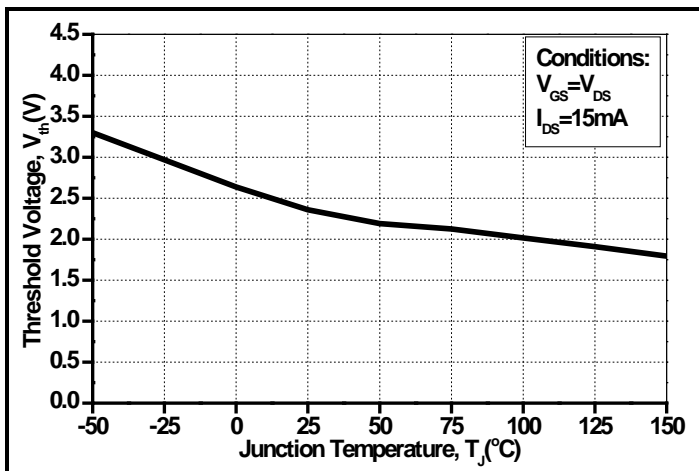

Figure 11. Threshold Voltage vs. Temperature

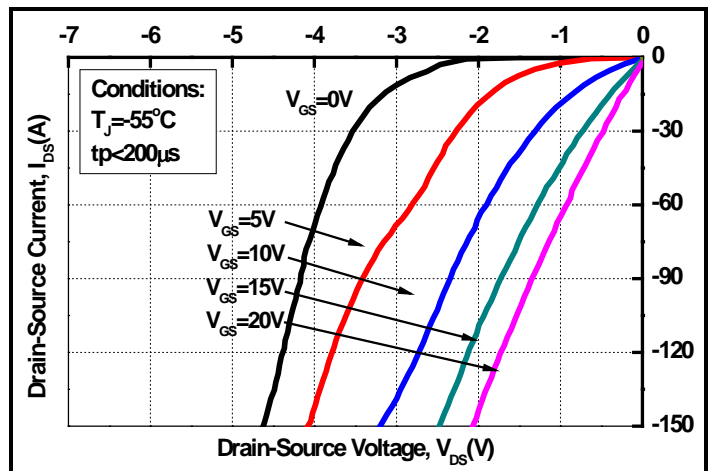

Figure 12. 3rd Quadrant Characteristic at -55°C



Typical Performance

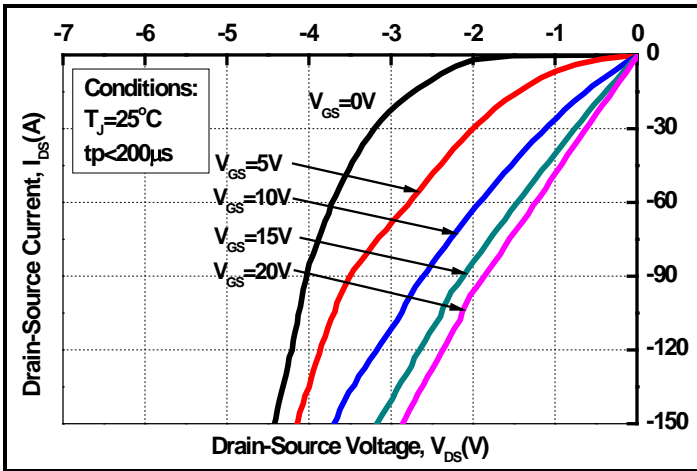

Figure 13. 3rd Quadrant Characteristic at 25°C

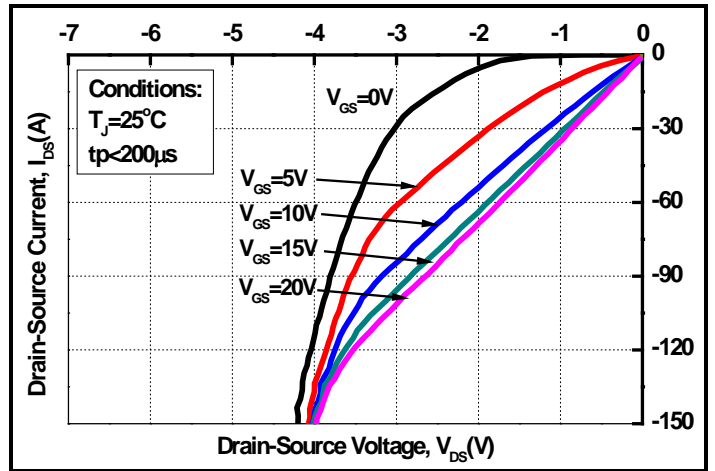

Figure 14. 3rd Quadrant Characteristic at 150°C

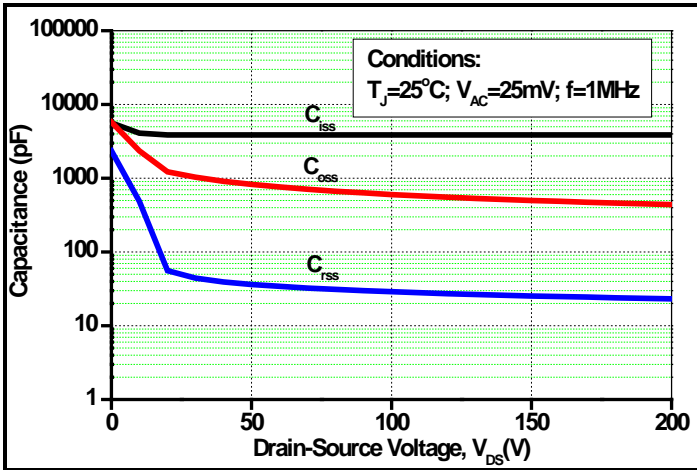

Figure 15. Capacitances vs. Drain-Source Voltage (0 - 200V)

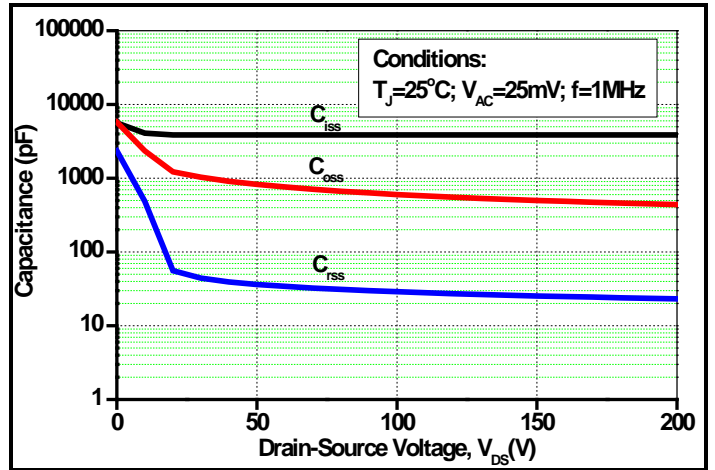
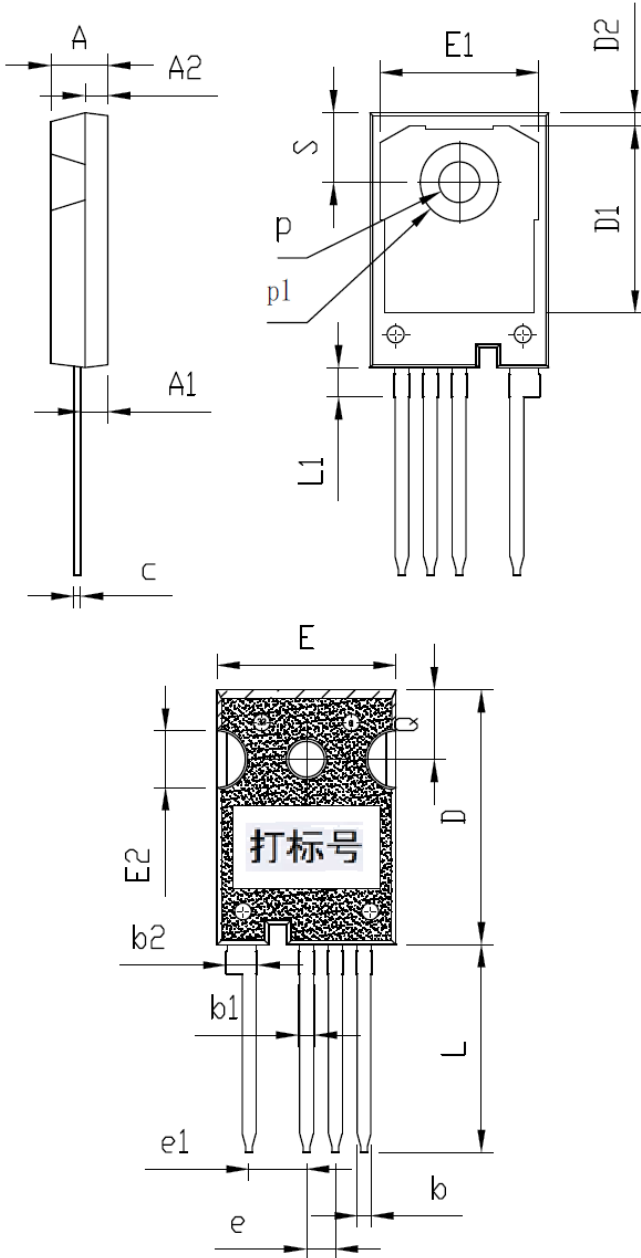

Figure 16. Capacitances vs. Drain-Source Voltage (0 - 1000V)



Package Dimensions

Package TO-247-4



SYMBOLS	DIMENSIONS IN MILLIMETERS		
	MIN	NOM	MAX
A		5.00	
A1		2.40	
A2		2.00	
b		1.20	
b1		1.30	
b2		2.65	
c		0.6	
D		22.54	
D1		16.50	
D2		1.17	
e		2.54	
e1		5.08	
E		15.80	
E1		14.00	
E2		5.00	
L		18.38	
L1		2.58	
p		3.60	
p1		6.80	
Q		6.15	
S		6.15	



Notes

- 1) Before using our products, please contact our marketing managers and get the latest specifications.
- 2) Ongoing efforts are being made to improve the reliability and quality of the products by X-IPM, but the semiconductors can malfunction due to various factors. Therefore, in order to prevent artificial damage or fire arising from failure, please take safety measures such as complying with the derating characteristics, implementing redundant and fire prevention designs, and utilizing backups and fail-safe procedures. X-IPM doesn't have responsibility for any damages arising from the use of our products beyond the rating specified by X-IPM.
- 3) All the information contained in this document, such as the examples of application circuits, circuit constants, is provided only to illustrate the standard usage and operations of the products. The other relevant conditions must be taken into consideration when designing circuits for mass production.
- 4) The information specified in this document is intended only to show the typical functions and examples of application circuits for the products. X-IPM does not grant you, explicitly or implicitly, any license to use or exercise intellectual property or other rights held by X-IPM or any other parties. X-IPM shall have no responsibility whatsoever for any dispute arising from the use of such technical information.
- 5) The products specified in this document are not designed to be radiation tolerant.
- 6) For use of our products in applications requiring a high degree of reliability (as exemplified below), please contact and consult with a X-IPM representative: transportation equipment (cars, ships, trains, etc.), primary communication equipment, traffic lights, fire/crime prevention, safety equipment, medical systems, and power transmission systems.
- 7) Do not use our products in applications requiring extremely high reliability, such as aerospace equipment, nuclear power control systems and submarine repeaters.
- 8) X-IPM shall not be responsible for any damages or injury caused by non-compliance with the recommended usage conditions and specifications contained in this document.
- 9) X-IPM has used reasonable care to ensure the accuracy of the information contained in this document. However, X-IPM does not guarantee the information contained in this document is totally correct, and X-IPM doesn't have responsibility for any damages arising from any inaccuracy or misprint of such information.
- 10) Please use the products in accordance with any applicable environmental laws and regulations, such as the RoHS Directive. For more details, including RoHS compatibility, please contact a X-IPM marketing manager. X-IPM doesn't have responsibility for any damages or losses arising from disobedience to any relevant laws or regulations.
- 11) When providing our products and technologies contained in this document to other countries or regions, you must comply with the procedures and provisions stipulated by all the applicable export laws and regulations, including but not limited to the relevant laws or regulations.
- 12) The information contained in this document is subject to change without notice.
- 13) Neither part nor all of this file is allowed to be reprinted or reproduced without authorization of X-IPM.
- 14) X-IPM reserves the right to the final interpretation.